

Data Sheet



Article number: 276106293401

Description: KLEEblower KB629L 3,4/3,7 kW
3x230/400V 50/60Hz Single stage

Measures

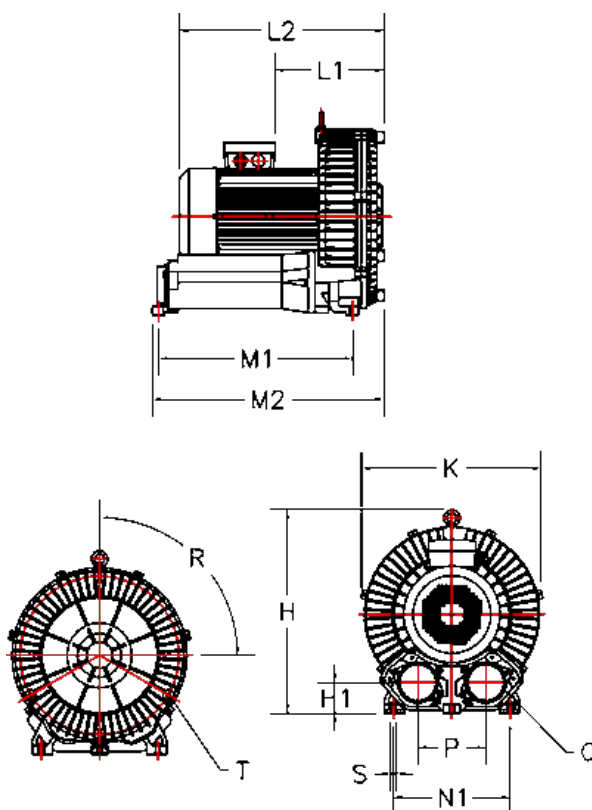

H = 416.5	N1 = 290
H1 = 50	Noise level dB 50/60Hz = 72/77
K = 383	P = 125
L1 = 186.5	Q = 2-PF 2" (NPT 2")
L2 = 413	R (degrees) = 3x120
M1 = 140	S = 4 x Ø15
M2 = 362	T = 3 - M8X1,25 - 20 dyb
N = 32	